

SINGER

246-21

LIST OF PARTS COMPLETE
FOR

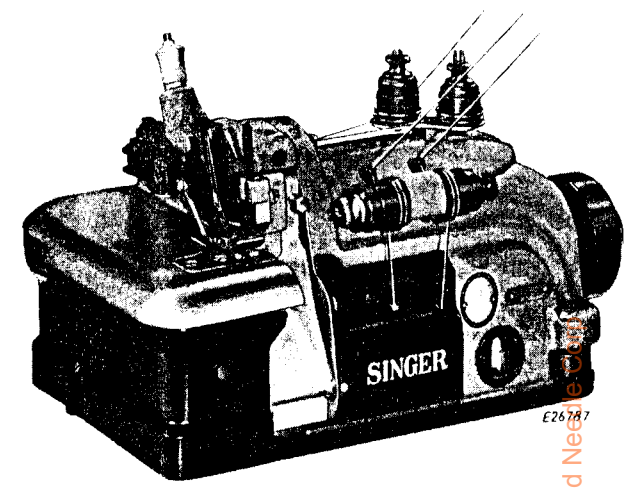

MACHINE No. 246-21

FOR TRIMMING AND OVEREDGING BATHING SUITS, HOUSE DRESSES AND SIMILAR ARTICLES, TWO NEEDLES, TWO LOOPERS. MAKES A FOUR-THREAD DUAL-STITCH. DISTANCE BETWEEN NEEDLES IS FIXED AT .109 INCHES. BIGHT 3/32" TO 9/32" FROM NEEDLE. MATERIAL UP TO 1/4 INCH IN THICKNESS CAN BE STITCHED. SPEED UP TO 5000, DEPENDING ON MATERIALS USED AND OPERATIONS PERFORMED.

SINGER Needles should be used
in SINGER Machines
These Needles and their Containers
are marked with the
Company's Trademark "SIMANCO" 1

Needles in Containers marked
"FOR SINGER MACHINES"
are NOT SINGER made needles 2

No.	Plate	Name
164864	24893	Chain Cutter Chain Retainer (spring).....
665J	24893	Chain Cutter Chain Retainer (spring) Screw
164865	24893	Chain Cutter with Chain Retainer complete, Nos. 164861, 164863, 164864 and two 665J
164863	24893	Chain Cutter Holder
164861	24893	Chain Cutter Knife
665J	24893	Chain Cutter Knife Screw
164765	24891	Chip Guard
1209J	24891	Chip Guard Screw (lower).....
140509J	24891	Chip Guard Screw (upper).....
164613	24891	Cloth Plate
164002	24891	Cloth Plate Extension.....
51408J	24891	Cloth Plate Extension Screw (2)
1700J	24891	Cloth Plate Extension Screw Nut.....
931084	24891	Cloth Plate Extension Screw Nut Lock Washer
164205	24891	Cloth Plate Lock Spring.....
1700J	24891	Cloth Plate Lock Spring Nut.....
931084	24891	Cloth Plate Lock Spring Nut Washer..
1250AL	24891	Cloth Plate Lock Spring Screw Stud

From the library of the Diamond Needle Co.

No.	Plate	Name
164104	24891	Cloth Plate Plunger.....
164105	24891	Cloth Plate Plunger Spring.....
624AL	24891	Cloth Plate Plunger Set Screw.....
164106	24891	Cloth Plate Position Collar with two 624AL
624AL	24891	Cloth Plate Position Collar Set Screw (2).
164614	24891	Cloth Plate with Extension complete, Nos. 164002, 164205, 164613 and two each 1700J, 51408J and 931084.....
164003	24879	Feed Bar Hinge Pin (eccentric).....
1389C	24879	Feed Bar Hinge Pin Set Screw.....
164004	24879	Feed Bar Slide Block (back) (2).....
1628C	24879	Feed Bar Slide Block (back) Nut.....
17022	24879	Feed Bar Slide Block (back) Nut Washer..
164366	24879	Feed Bar Slide Block (front).....
164687	24879	Feed (back) Bar with 164010.....
164017	24879	Feed (back) Bar Connection.....
164008	24879	Feed (back) Bar Connection Bearing.....
164009	24879	Feed (back) Bar Connection Hinge Screw Stud.....
1671C	24879	Feed (back) Bar Connection Hinge Screw Stud Nut.....
164010	24879	Feed (back) Bar Connection Hinge Screw Stud Position Pin.....
164615	24898	Feed (back) Dog Section (left).....
164616	24898	Feed (back) Dog Section (right).....
1100AL	24898	Feed (back) Dog Section (right) Screw....
164617	24898	Feed (back) Dog complete, Nos. 1100AL, 164615 and 164616.....
1454F	24898	Feed (back) Dog Screw.....
164020	24879	Feed (back) Eccentric.....
		NOTE: Feed (back) Eccentric No. 164020 is furnished in 6 to 16, 18, 20, 22, 24, 28, 32 and 36 stitches to the inch.
164006	24879	Feed (front) Bar with 164010.....
164007	24879	Feed (front) Bar Connection.....
164018	24879	Feed (front) Bar Connection Bearing.....
164009	24879	Feed (front) Bar Connection Hinge Screw Stud.....
1671C	24879	Feed (front) Bar Connection Hinge Screw Stud Nut.....
164010	24879	Feed (front) Bar Connection Hinge Screw Stud Position Pin.....
164370	-----	Feed (back) and (front) Bars complete, Nos. 164006, 164007, 164008, 164017, 164018, 164366, 164687 and two each 1671C, 164004 and 164009.....
164808	24898	Feed (front) Dog.....
1454F	24898	Feed (front) Dog Screw.....
164020	24879	Feed (front) Eccentric.....
		NOTE: Feed (front) Eccentric No. 164020 is furnished in 6 to 16, 18, 20, 22, 24, 28, 32 and 36 stitches to the inch.
164520	24879	Feed Eccentric Cover.....
164399	24879	Feed Eccentric Cover Bracket with 164023

No.	Plate	Name
157C	24879	Feed Eccentric Cover Bracket Screw.....
629K	24879	Feed Eccentric Cover Hinge Screw.....
164401	24879	Feed Eccentric Cover Latch Spring.....
227J	24879	Feed Eccentric Cover Latch Spring Screw (2).....
164023	24879	Feed Eccentric Oil Wick.....
164521	24879	Feed Eccentric Cover complete, for use with eccentric of 4 stitches and above, Nos. 629K, 164399, 164401, 164520 and two 227J.....
164372	24892	Feed Lifting and Thread Needle Controller Lever Eccentric.....
42305	-----	Knife (movable) Body.....
164809	24894	Knife (movable) with 42305.....
164810	24894	Knife (movable) Holder with 1147AL.....
164811	24894	Knife (movable) Holder Gib.....
1147AL	24894	Knife (movable) Holder Gib Screw.....
176J	24894	Knife (movable) Holder Screw.....
164030	24894	Knife (movable) Holder Screw Bearing...
164714	24894	Knife (movable) Lever with 620AL.....
164715	-----	Knife (movable) Lever 164714 with 132583 164035, 164136 and 164153.....
164032	24894	Knife (movable) Lever Bearing.....
447AL	24894	Knife (movable) Lever Bearing Set Screw (long).....
624AL	24894	Knife (movable) Lever Bearing Set Screw (short).....
164373	24897	Knife (movable) Lever Cover and Presser Bar (upright) Housing with 1259AL.....
		NOTE: No. 1259AL has no application in this list.
50073J	24897	Knife (movable) Lever Cover and Presser Bar (upright) Housing Screw (2).....
164812	-----	Knife (movable) Lever Cover and Presser Bar (upright) Housing complete, Nos. 50060K, 164137, 164139, 164142, 164143, 164194, 164373, 164814, 164815 and 164884.....
164180	24893	Knife (movable) Lever Guide.....
164181	24893	Knife (movable) Lever Guide Holder with two 140239AL.....
140239AL	24893	Knife (movable) Lever Guide Holder Set Screw.....
164824	24893	Knife (movable) Lever Guide Holder 164181 with 197J, 164180, 164823 and 164827.....
164823	24893	Knife (movable) Lever Guide Holder Thread Tube.....
447AL	24893	Knife (movable) Lever Guide Holder Thread Tube Set Screw.....
197J	24893	Knife (movable) Lever Guide Screw.....
132583	24894	Knife (movable) Lever Hinge Pin with 132584.....
132584	24894	Knife (movable) Lever Hinge Pin Oil Wick
620AL	24894	Knife (movable) Lever Hinge Pin Set Screw.....

No.	Plate	Name
164034	24894	Knife (movable) Lever Hinge Stud.....
164035	-----	Knife (movable) Lever Hinge Stud 164034 with 164036 and 164269
164036	24894	Knife (movable) Lever Hinge Stud Oil Wick (long).....
164269	-----	Knife (movable) Lever Hinge Stud Oil Wick (short).....
447AL	24894	Knife (movable) Lever Hinge Stud Set Screw (back)
1143AL	24894	Knife (movable) Lever Hinge Stud Set Screw (top)
164813	24894	Knife (stationary).....
164744	24894	Knife (stationary) Clamping Gib
140788C	24894	Knife (stationary) Clamping Gib Screw ...
3146	24894	Knife (stationary) Clamping Gib Screw Washer
164746	24894	Knife (stationary) Holder
164747	-----	Knife (stationary) Holder (adjustable) complete, Nos. 742F, 164745 and 164746
164748	24894	Knife (stationary) Holder (adjustable) with Gib complete, Nos. 3146, 140788C, 164744 and 164747.....
164590	24894	Knife (stationary) Holder Adjusting Stud ..
190E	24894	Knife (stationary) Holder Adjusting Stud Cap Screw.....
39541	24894	Knife (stationary) Holder Adjusting Stud Cap Screw Washer
164745	24894	Knife (stationary) Holder Body with two 50611C
50611C	24894	Knife (stationary) Holder Position Screw (2)
742F	24894	Knife (stationary) Holder Screw
164042	24894	Knife (stationary) Holder Sleeve
140088E	24894	Knife (stationary) Holder Sleeve Screw ...
175032	24894	Knife (stationary) Holder Sleeve Screw Washer
164043	24894	Knife (stationary) Holder Spring.....
164525	24894	Knife (stationary) Holder Spring Stud.....
bottom 164619	24895	Looper (left hand).....
164046	24895	Looper (left hand) Carrier with 460AL, 50379F and 164202
164660	24895	Looper (left hand) Carrier Holder with 1083C, 140393AL and 140596AL.....
164661	-----	Looper (left hand) Carrier Holder 164660 with 1324C, 59456 and 164046
1083C	24895	Looper (left hand) Carrier Holder Clamp- ing Screw
140596AL	-----	Looper (left hand) Carrier Holder Set Screw (left)
140393AL	24895	Looper (left hand) Carrier Holder Set Screw (right).....
1324C	24895	Looper (left hand) Carrier Screw
460AL	24895	Looper (left hand) Carrier Screw Set Screw.....

No.	Plate	Name
59456	24895	Looper (left hand) Carrier Screw Washer.
164048	24895	Looper (left hand) Driving Shaft
164049	24895	Looper (left hand) Driving Shaft Bushing (back)
140394E	24895	Looper (left hand) Driving Shaft Bushing (back) Cap Screw
164293	24895	Looper (left hand) Driving Shaft Bushing (back) Cap Screw Washer.....
164737	24895	Looper (left hand) Driving Shaft Bushing (front).....
164051	24895	Looper (left hand) Driving Shaft Crank with 1083C
1083C	24895	Looper (left hand) Driving Shaft Crank Clamping Screw.....
164052	24892	Looper (left hand) Driving Shaft Crank Connection with two each 171AL and 140159AL
164215	-----	Looper (left hand) Driving Shaft Crank 164051 with 164052.....
171AL	24892	Looper (left hand) Driving Shaft Crank Connection Cap (lower) Screw (2).....
140159AL	24892	Looper (left hand) Driving Shaft Crank Connection Cap (upper) Screw (2).....
164067	24895	Looper (left hand) Driving Shaft Crank Key
1324C	24895	Looper (left hand) Driving Shaft Crank Key Screw.....
45057	24895	Looper (left hand) Driving Shaft Crank Key Screw Washer
164053	24895	Looper (left hand) Driving Shaft Crank Thrust Bearing
164739	24895	Looper (left hand) Driving Shaft Oil Ring (rubber)
164740	24895	Looper (left hand) Driving Shaft Oil Ring Spacer.....
50379F	24895	Looper (left hand) Set Screw
164202	24895	Looper (left hand) Stop Pin.....
164054	24898	Looper (left hand) Thread Tube.....
853AL	24898	Looper (left hand) Thread Tube Set Screw.
164375	24895	Looper (right hand)
164781	24895	Looper (right hand) Carrier with 50370AL
164782	24895	Looper (right hand) Carrier Connection ..
164783	-----	Looper (right hand) Carrier Connection and Guide Bar 164782 with 1700J, 50420AL, 164785 and 164786.....
164784	24895	Looper (right hand) Carrier Connection Guide Bar Bracket with 51369C.....
914C	24895	Looper (right hand) Carrier Connection Guide Bar Bracket Screw (left).....
1057AL	24895	Looper (right hand) Carrier Connection Guide Bar Bracket Screw (right).....
51369C	24895	Looper (right hand) Carrier Connection Guide Bar Clamping Screw.....
164785	24895	Looper (right hand) Carrier Connection Guide Bar Oil Controlling Screw Seat (Brass).....

 From the library of: www.industrylib.com

No.	Plate	Name
50420AL	24895	Looper (right hand) Carrier Connection Guide Bar Oil Plug Screw.....
1700J	24895	Looper (right hand) Carrier Connection Guide Bar Oil Plug Screw Nut.....
164786	24895	Looper (right hand) Carrier Connection Guide Bar Oil Wick.....
164061	24895	Looper (right hand) Carrier Connection Hinge Stud with 1019AL.....
1443J	24895	Looper (right hand) Carrier Connection Hinge Stud Cap Screw.....
164397	24895	Looper (right hand) Carrier Connection Hinge Stud Adjusting Pin.....
1019AL	----	Looper (right hand) Carrier Connection Hinge Stud Adjusting Pin Set Screw.....
132565	24895	Looper (right hand) Carrier Hinge Pin....
50370AL	24895	Looper (right hand) Carrier Hinge Pin Set Screw.....
164062	24895	Looper (right hand) Driving Lever with 1083C and two 140596AL.....
164787	-----	Looper (right hand) Driving Lever 164062 with 1443J, 132565, 164061, 164068, 164397, 164781, 164783 and 164784.....
1083C	24895	Looper (right hand) Driving Lever Clamp- ing Screw.....
140596AL	24895	Looper (right hand) Driving Lever Set Screw (2).....
164063	24895	Looper (right hand) Driving Shaft.....
164049	24895	Looper (right hand) Driving Shaft Bushing (back).....
140394E	24895	Looper (right hand) Driving Shaft Bushing (back) Cap Screw.....
164293	24895	Looper (right hand) Driving Shaft Bushing (back) Cap Screw Washer.....
164738	24895	Looper (right hand) Driving Shaft Bushing (front).....
164066	24895	Looper (right hand) Driving Shaft Crank with 1083C.....
164216	-----	Looper (right hand) Driving Shaft Crank 164066 with 164052.....
1083C	24895	Looper (right hand) Driving Shaft Crank Clamping Screw.....
164052	24892	Looper (right hand) Driving Shaft Crank Connection with two each 171AL and 140159AL.....
171AL	24892	Looper (right hand) Driving Shaft Crank Connection Cap (lower) Screw (2).....
140159AL	24892	Looper (right hand) Driving Shaft Crank Connection Cap (upper) Screw (2).....
164067	24895	Looper (right hand) Driving Shaft Crank Key.....
1324C	24895	Looper (right hand) Driving Shaft Crank Key Screw.....
45057	24895	Looper (right hand) Driving Shaft Crank Key Screw Washer.....

No.	Plate	Name
164053	24895	Looper (right hand) Driving Shaft Crank Thrust Bearing.....
164739	24895	Looper (right hand) Driving Shaft Oil Ring (rubber).....
164740	24895	Looper (right hand) Driving Shaft Oil Ring Spacer.....
164068	24895	Looper (right hand) Locking Screw Stud...
1700J	24895	Looper (right hand) Locking Screw Stud Nut.....
164219	24895	Looper (right hand) Position Collar with 904AL.....
904AL	24895	Looper (right hand) Position Collar Set Screw.....
*164072	----	Machine Frame.....
*164526	----	Machine Frame complete, Nos. 140396E, 164072, 164077, 164528 and three 140395E
164074	24813	Machine Frame Bottom Cover.....
164075	24813	Machine Frame Bottom Cover Gasket....
914C	24813	Machine Frame Bottom Cover Screw (13)...
*164527	----	Machine Frame Bracket.....
*164528	----	Machine Frame Bracket 164527 with 164207 and two 187E.....
164207	24860	Machine Frame Bracket Key.....
187E	24860	Machine Frame Bracket Key Screw (2)....
140395C	24860	Machine Frame Bracket Screw (small) (3)
140396E	24860	Machine Frame Bracket Screw (large)....
164077	24860	Machine Frame Bracket Screw (large) Washer (fiber).....
164229	24860	Machine Frame Bracket Screw (large) Washer (felt).....
164515	24813	Machine Frame Cover (back).....
50571J	24813	Machine Frame Cover (back) Screw (long) (2).....
914J	24813	Machine Frame Cover (back) Screw (short)
164516	24813	Machine Frame Cover (back) 164515 with 1637K and 140228C.....
164081	24860	Machine Frame Oil Lead.....
140088E	24860	Machine Frame Oil Lead Screw.....
1698J	24860	Machine Frame Oil Lead Screw Nut.....
164082	24860	Machine Frame Oil Plug Bracket.....
140346AL	24860	Machine Frame Oil Plug Bracket Set Screw
164083	24860	Machine Frame Oil Screen.....
206J	24860	Machine Frame Oil Screen Screw (3)....
164608	24860	Machine Frame Oil Splash Guard (internal)
164605	24860	Machine Frame Oil Splash Guard (internal) Oil Pad.....
164606	24860	Machine Frame Oil Splash Guard (internal) Oil Pad Fastener.....
164609	24860	Machine Frame Oil Splash Guard (internal) complete, Nos. 164605, 164606 and 164608.....
164620	24897	Machine Frame Oil Splash Guard (top)....
51023W	24897	Machine Frame Oil Splash Guard (top) Screw (2).....

No.	Plate	Name
164722	24860	Machine Frame Oil Tube with 164602.....
447AL	24860	Machine Frame Oil Tube Set Screw
164602	24860	Machine Frame Oil Tube Wick.....
164788	24892	Machine Frame Rotary Shaft
164789	-----	Machine Frame Rotary Shaft 164788 with 164097, 164215, 164216, 164217 and two each 164093 and 164232.....
139026	24892	Machine Frame Rotary Shaft Ball Bearing
164092	24892	Machine Frame Rotary Shaft Ball Bearing Housing
51369C	24892	Machine Frame Rotary Shaft Ball Bearing Housing Screw (3).....
164093	24892	Machine Frame Rotary Shaft Sleeve (two pieces) (2)
164232	24892	Machine Frame Rotary Shaft Ball Sleeve Guide (2).....
164600	24892	Machine Frame Rotary Shaft Bushing (front)
1036AL	24892	Machine Frame Rotary Shaft Bushing (front) Set Screw.....
164095	24892	Machine Frame Rotary Shaft Bushing (intermediate).....
51332C	24892	Machine Frame Rotary Shaft Bushing (intermediate) Set Screw.....
164096	24892	Machine Frame Rotary Shaft Counter- balance with 1036AL.....
1036AL	24892	Machine Frame Rotary Shaft Counter- balance Set Screw.....
164097	24892	Machine Frame Rotary Shaft Key
51649C	24892	Machine Frame Rotary Shaft Nut.....
131056	24892	Machine Frame Rotary Shaft Nut Washer ..
164098	24892	Machine Frame Rotary Shaft Oil Return and Ball Bearing Grease Retainer.....
164099	24892	Machine Frame Rotary Shaft Screw Stud..
164100	24892	Machine Frame Rotary Shaft Thrust Bearing.....
164101	24885	Machine Frame Top Cover
164214	-----	Machine Frame Top Cover 164101 with 330J, 164103 and two 164418.....
164102	24885	Machine Frame Top Cover Gasket
164103	24885	Machine Frame Top Cover Oil Lead.....
330J	24885	Machine Frame Top Cover Oil Lead Screw
51369J	24885	Machine Frame Top Cover Screw (3)....
164231	24892	Machine Pulley (3/8 in. "V" belt) with two 448AL
164071	24892	Machine Pulley Cap
140416X	24892	Machine Pulley Cap Screw
448AL	24892	Machine Pulley Set Screw (2).....
164621	24897	Needle Clamp
51768C	24897	Needle Clamping Nut
175032C	24897	Needle Clamping Nut Washer.....
164622	24897	Needle Driving Shaft with 164625.....
164684	-----	Needle Driving Shaft 164622 with 51768C, 164621, 164685 and 175032C

No.	Plate	Name
164111	24897	Needle Driving Shaft Bushing.....
164112	24897	Needle Driving Shaft Bushing Cap.....
164113	24897	Needle Driving Shaft Bushing Oil Lead
452AL	24897	Needle Driving Shaft Bushing Oil Lead Hole Plug Screw
164114	24897	Needle Driving Shaft Crank with 1083C and two 140596AL
164115	24897	Needle Driving Shaft Crank Ball.....
1083C	24897	Needle Driving Shaft Crank Clamping Screw
164217	24892	Needle Driving Shaft Crank Connection with 164115 and two each 157AL and 171AL ..
157AL	24892	Needle Driving Shaft Crank Connection Cap (lower) Screw (2).....
171AL	24892	Needle Driving Shaft Crank Connection Cap (upper) Screw (2).....
140596AL	24897	Needle Driving Shaft Crank Set Screw (2) ..
164685	24897	Needle Holder
164625	24897	Needle Stop Pin
164119	24892	Oil Agitator
164120	24860	Oil Cooler, with two 164125.....
164121	24860	Oil Cooler Cover
164123	24860	Oil Cooler Cover 164121 with 164135.....
164122	24860	Oil Cooler Cover Gasket.....
145J	24860	Oil Cooler Cover Screw
164124	24860	Oil Cooler Gasket.....
164125	24860	Oil Cooler Oil Pipe (outlet, left)
164125	24860	Oil Cooler Oil Pipe (outlet, right).....
164126	24860	Oil Cooler Oil Tube with 138269 and 164128
164736	-----	Oil Cooler Oil Tube 164126 with 51630 and 164127.....
164127	24860	Oil Cooler Oil Tube Coupling.....
51630	24860	Oil Cooler Oil Tube Lock Nut
138269	24860	Oil Cooler Oil Tube Sleeve.....
164128	24860	Oil Cooler Oil Tube Wick
51139J	24860	Oil Cooler Screw (long) (2)
1324J	24860	Oil Cooler Screw (short)
164135	24860	Oil Cup for filling machine.....
164607	24894	Oil Deflector
164131	24860	Oil Sight Gauge Background Disc
164132	24860	Oil Sight Gauge Background Disc Gasket...
164133	24860	Oil Sight Gauge Window.....
164132	24860	Oil Sight Gauge Window Gasket.....
164134	24860	Oil Sight Gauge Window Retainer
164132	24860	Oil Sight Gauge Window Retainer Gasket...
1485J	24860	Oil Sight Gauge Window Retainer Screw (2)
164136	24894	Presser Bar Bracket.....
164137	24897	Presser Bar Lifting Bracket with 462AL, 624AL and 51846.....
51846	24897	Presser Bar Lifting Bracket Roller and Stud.....
624AL	24897	Presser Bar Lifting Bracket Set Screw (long)
462AL	24897	Presser Bar Lifting Bracket Set Screw (short)

No.	Plate	Name
164884	24897	Presser Bar Lifting Lever.....
164139	24897	Presser Bar Lifting Lever Spring
140228C	24813	Presser Bar Lifting Lever Stop Screw ...
1637K	24813	Presser Bar Lifting Lever Stop Screw Nut
164640	24893	Presser Bar (swing-out)
164141	24893	Presser Bar (swing-out) Lifting Screw Stud
1700J	24893	Presser Bar (swing-out) Lifting Screw Stud Nut
164142	24897	Presser Bar (swing-out) Opening Lever..
5006JK	24897	Presser Bar (swing-out) Opening Lever Hinge Screw.....
140510C	24893	Presser Bar (swing-out) Pivot Screw....
164351	24893	Presser Bar (swing-out) Pivot Screw Lock Washer.....
51362AL	24893	Presser Bar (swing-out) Pivot Screw Lock Washer Screw.....
164143	24897	Presser Bar (upright).....
164814	24897	Presser Bar (upright) Spring
164815	24897	Presser Bar (upright) Spring Spacing Collar.....
164816	24898	Presser Foot Body.....
164146	24898	Presser Foot Chaining-off Finger
164147	24898	Presser Foot Clamping Plate
50255J	24898	Presser Foot Clamping Plate Screw
164817	24898	Presser Foot complete, Nos. 50225J, 164146, 164147 and 164816
140180J	24898	Presser Foot Screw.....
164194	24897	Pressure Regulating Thumb Screw.....
2102	24885	Tension (heavy) Disc (6).....
164155	24885	Tension (heavy) Regulating Thumb Nut (3)
50133C	24885	Tension (heavy) Screw Stud (3).....
1700J	24885	Tension (heavy) Screw Stud Nut (2)
164156	-----	Tension (heavy) Screw Stud 50133C and 164155 (3)
164161	24885	Tension (heavy) Spring (3).....
59537	24885	Tension (heavy) Spring Bushing (3)
164158	24885	Tension (heavy) Spring Cover (3).....
164162	24885	Tension (heavy) complete, Nos. 59537, 164156, 164158, 164161 and two 2102 (3).
2102	24885	Tension (light) Disc (2).....
164155	24885	Tension (light) Regulating Thumb Nut....
50133C	24885	Tension (light) Screw Stud.....
164156	-----	Tension (light) Screw Stud 50133C with 164155
164157	24885	Tension (light) Spring.....
59537	24885	Tension (light) Spring Bushing
164158	24885	Tension (light) Spring Cover.....
164160	24885	Tension (light) complete, Nos. 59537, 164156, 164157, 164158 and two 2102....
164285	24885	Tension (looper thread) Thread Guide (left).....
164286	24885	Tension (looper thread) Thread Guide (right).....

No.	Plate	Name
164418	24885	Tension Thread Eyelet (2).....
164628	24885	Tension Thread Guide (double)
1353AL	24885	Tension Thread Guide Screw
164629	24885	Tension Thread Guide Spacing Block
164630	24885	Tension (double) complete, Nos. 164628 and two each 1700J and 164162.....
164825	24893	Thread Eyelet (needle thread)
164826	24893	Thread Eyelet (needle thread) Holder
164827	-----	Thread Eyelet (needle thread) Holder 164826 with 1607J and 164825
1607J	24893	Thread Eyelet (needle thread) Nut
140239AL	24893	Thread Eyelet (needle thread) Set Screw..
164091	24895	Thread (looper, right hand) Stripper and Take-up with 164555.....
164163	24896	Thread (looper, right hand) Stripper and Take-up Eyelet (adjustable)
1443J	24896	Thread (looper, right hand) Stripper and Take-up Eyelet (adjustable) Screw
164555	-----	Thread (looper, right hand) Stripper and Take-up Guide Wire.....
187E	24895	Thread (looper, right hand) Stripper and Take-up Screw.....
17022	24895	Thread (looper, right hand) Stripper and Take-up Screw Washer
164164	24896	Thread (looper, right hand) Thread Eyelet (movable).....
1423J	24896	Thread (looper, right hand) Thread Eyelet Screw.....
164165	24896	Thread (looper, right hand) Thread Eyelet (stationary)
1607J	24896	Thread (looper, right hand) Thread Eyelet (stationary) Nut.....
164166	24896	Thread (looper, right hand) Tube.....
624AL	24896	Thread (looper, right hand) Tube Set Screw.....
164801	24896	Thread (looper) Plate with 624AL.....
164168	24896	Thread (looper) Plate Cover
164206	-----	Thread (looper) Plate Cover 164168 with 164169 and 164170.....
164169	24896	Thread (looper) Plate Cover Hinge.....
164170	24896	Thread (looper) Plate Cover Hinge Pin ...
164171	24896	Thread (looper) Plate Cover Spring (2) ..
332J	24896	Thread (looper) Plate Cover Spring Screw (2)
896AL	24896	Thread (looper) Plate Screw (2).....
164173	24896	Thread (looper) Plate Thread Bushing....
50318W	24896	Thread (looper) Plate Thread Bushing Screw
164802	-----	Thread (looper) Plate complete, Nos. 1423J, 1443J, 1607J, 50318W, 164163, 164164, 164165, 164166, 164173, 164206, 164801 and two each 332J and 164171 ...
164175	24895	Thread (looper) Take-up.....
164176	24895	Thread (looper) Take-up Plate

No.	Plate	Name
190E	24895	Thread (looper) Take-up Screw (lower)...
1443J	24895	Thread (looper) Take-up Screw (upper)...
164151	24894	Thread (needle) Controller
164153	24894	Thread (needle) Controller Lever
1443J	24894	Thread (needle) Controller Screw (2).....
164818	24898	Throat Plate
164591	24898	Throat Plate Guide with 853AL.....
1454E	24898	Throat Plate Guide Screw
1094F	24898	Throat Plate Screw (2).....

ACCESSORIES

No.	Plate	Name
164203	24890	Feed Eccentric Extractor (not regularly furnished with machine)
164883	24890	Gauge (not regularly furnished with machine)
160725	24890	Oil Container
160727	24890	Oil Container, Nos. 160725 and 160726 ...
160726	24890	Oil Container Cap
160728	24890	Oil Container Spout, for use when filling Oil Reservoir
164198	24890	Presser Bar Lifting Chain Spring (under table)
26026	24890	Screw Driver
164196	24890	Threader (6)
164204	24890	Tweezers
164197	24890	Wrench (socket)
164831	24890	Wrench for 1700
8908	24890	Wrench (flat)

BELT GUARD (Adjustable)

No.	Plate	Name
164183	24866	Belt Guard
164199	24866	Belt Guard Bracket (back)
164200	24866	Belt Guard Bracket (front)
51326J	24866	Belt Guard Screw (2)
164201	24866	Belt Guard (adjustable) complete) Nos. 164183, 164199, 164200 and two each 51326J and wood screws 3/4 in. No. 7 F. H.

CHIP CHUTE

No.	Plate	Name
168198	24866	Chip Chute with four wood screws 3/8 in. No. 6 R. H. blacked

FOOT LIFTER PARTS

No.	Plate	Name
6439	24866	Chain 36 in. to 45 in., with 56864 and 56865
NOTE: When ordering No. 6439, give length required.		
4879	24866	Chain Connecting Link
56864	24866	Chain Hook (large)
56865	24866	Chain Hook (small)
4881	24866	Treadle
4882	24866	Treadle Shaft
4883	-----	Treadle Spring
4884	24866	Treadle Stand
4885	24866	Treadle complete, Nos. 4879, 4881, 4882, 4883, 4884 and two wood screws 1 in. No. 16 F. H.

MACHINE BASE

No.	Plate	Name
164184	24866	Machine Base and two each wood screws 3/4 in. No. 8 R. H. and 1-1/4 in. No. 6 F. H.
164188	24866	Machine Cushion (large) (2)
164189	24866	Machine Cushion (small) (2)
164190	24866	Machine Pad (felt)
140418	24892	Machine Screw Stud (back)
657E	24892	Machine Screw Stud (front)

THREAD UNWINDER NO. 151163
FOR FOUR SPOOLS

No.	Plate	Name
228692	24867	Spool Pin (3).....
228764	24867	Spool Pin.....
201528X	-----	Spool Pin Nut (3).....
395243	-----	Spool Pin Washer (3).....
151023	24867	Spool Rest with 858AL and three each 201528X, 228692 and 395243 (three spools).....
228765	24867	Spool Rest with 201254C.....
150203	24867	Spool Rest Cushion (felt) (4).....
858AL	24867	Spool Rest Hub Set Screw.....
151024	24867	Spool Rest Rod.....
1122C	24867	Spool Rest Rod Set Screw (2).....
201254C	24867	Spool Rest Set Screw.....
151025	24867	Spool Rest Stand with two 1122C and three wood screws 1 in. No. 12 F. H.....
151026	24867	Thread Guide (lower).....
50311C	24867	Thread Guide (lower) Holder Set Screw... ..
151027	24867	Thread Guide (lower) Support with 50311C.....
151028	24867	Thread Guide (upper, hollow) (2).....
151162	24867	Thread Guide (upper, solid).....
151029	24867	Thread Guide (upper) Holder with four 453AL.....
453AL	24867	Thread Guide Set Screw (3).....
151030	24867	Thread Guide Rod.....
453AL	24867	Thread Guide Rod Set Screw.....
151163	24867	Thread Unwinder complete, Nos. 151023, 151024, 151025, 151026, 151027, 151029, 151030, 151162, 228764, 228765, two 151028 and four 150203.....

NUMERICAL LIST OF PARTS

No.	Plate	Name
145J	24860	Oil Cooler Cover Screw.....
157C	24879	Feed Eccentric Cover Bracket Screw.....
157AL	24892	Needle Driving Shaft Crank Connection Cap (lower) Screw for 164217.....
171AL	24892	Looper (left hand) Driving Shaft Crank Connection Cap (lower) Screw for 164052.....
171AL	24892	Looper (right hand) Driving Shaft Crank Connection Cap (lower) Screw for 164052.....
171AL	24892	Needle Driving Shaft Crank Connection Cap (upper) Screw for 164217.....
176J	24894	Knife (movable) Holder Screw.....
187E	24860	Machine Frame Bracket Key Screw for 164528.....
187E	24895	Thread (looper, right hand) Stripper and Take-up Screw.....
190E	24894	Knife (stationary) Holder Adjusting Stud Cap Screw.....
190E	24895	Thread (looper) Take-up Screw (lower) ..
197J	24893	Knife (movable) Lever Guide Screw for 164824.....
206J	24860	Machine Frame Oil Screen Screw.....
227J	24879	Feed Eccentric Cover Latch Spring Screw for 164521.....
330J	24885	Machine Frame Top Cover Oil Lead Screw for 164214.....
332J	24896	Thread (looper) Plate Cover Spring Screw for 164802.....
447AL	24894	Knife (movable) Lever Bearing Set Screw (long).....
447AL	24893	Knife (movable) Lever Guide Holder Thread Tube Set Screw.....
447AL	24894	Knife (movable) Lever Hinge Stud Set Screw (back).....
447AL	24860	Machine Frame Oil Tube Set Screw.....
448AL	24892	Machine Pulley Set Screw for 164231.....
452AL	24897	Needle Driving Shaft Bushing Oil Lead Hole Plug Screw.....
453AL	24867	Thread Unwinder Thread Guide Set Screw for 151029.....
453AL	24867	Thread Unwinder Thread Guide Rod Set Screw for 151029.....
460AL	24895	Looper (left hand) Carrier Set Screw for 164046.....
462AL	24897	Presser Bar Lifting Bracket Set Screw (short) 164137.....
620AL	24894	Knife (movable) Lever Hinge Pin Set Screw for 164714.....
624AL	24891	Cloth Plate Plunger Set Screw.....
624AL	24891	Cloth Plate Position Collar Set Screw for 164106.....

No.	Plate	Name
164825	24893	Thread Eyelet Needle Thread for 164827...
164826	24893	Thread Eyelet Needle Thread Holder for 164827.....
164827	-----	Thread Eyelet Needle Thread Holder 164826 with 1607J and 164825, for 164824
164831	24890	Wrench for 1700 (accessories)
164861	24893	Chain Cutter Knife for 164865
164863	24893	Chain Cutter Holder for 164865
164864	24893	Chain Cutter Chain Retainer (spring) for 164865.....
164865	24893	Chain Cutter with Chain Retainer complete, Nos. 164861, 164863, 164864 and two 665J.....
164883	24890	Gauge (accessories) not regularly furnished with machine
164884	24897	Presser Bar Lifting Lever for 164812.....
168198	24866	Chip Chute with four wood screws 3/8 in. No. 6 R. H. blacked
175032	24894	Knife (stationary) Holder Sleeve Screw Washer
175032C	24897	Needle Clamping Nut Washer for 174684...
201254C	24867	Thread Unwinder Spool Rest Set Screw for 228765.....
201528X	-----	Thread Unwinder Spool Pin Nut for 151023 ..
228692	24867	Thread Unwinder Spool Pin for 151023.....
228764	24867	Thread Unwinder Spool Pin for 151163.....
228765	24867	Thread Unwinder Spool Rest with 201254C, for 151163
395243	-----	Thread Unwinder Spool Pin Washer for 151023.....
931084	24891	Cloth Plate Extension Screw Nut Lock Washer for 164614
931084	24891	Cloth Plate Lock Spring Nut Lock Washer for 164614.....

**SINGER Needles should be used
in SINGER Machines
These Needles and their Containers
are marked with the
Company's Trademark "SIMANCO" 1**

**Needles in Containers marked
"FOR SINGER MACHINES"
are NOT SINGER made needles 2**

24813-1/3

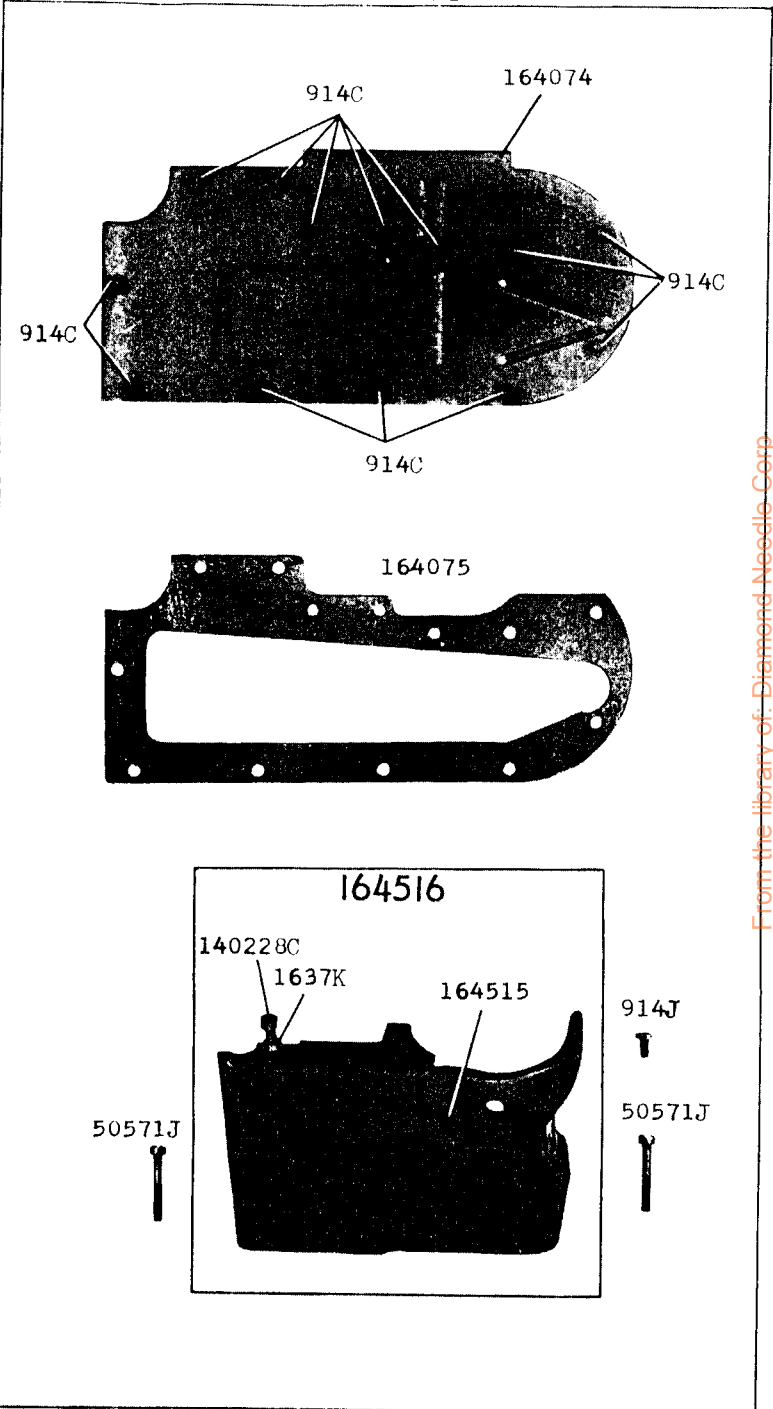

From the library of: Diamond Needle Corp

24860-1/3

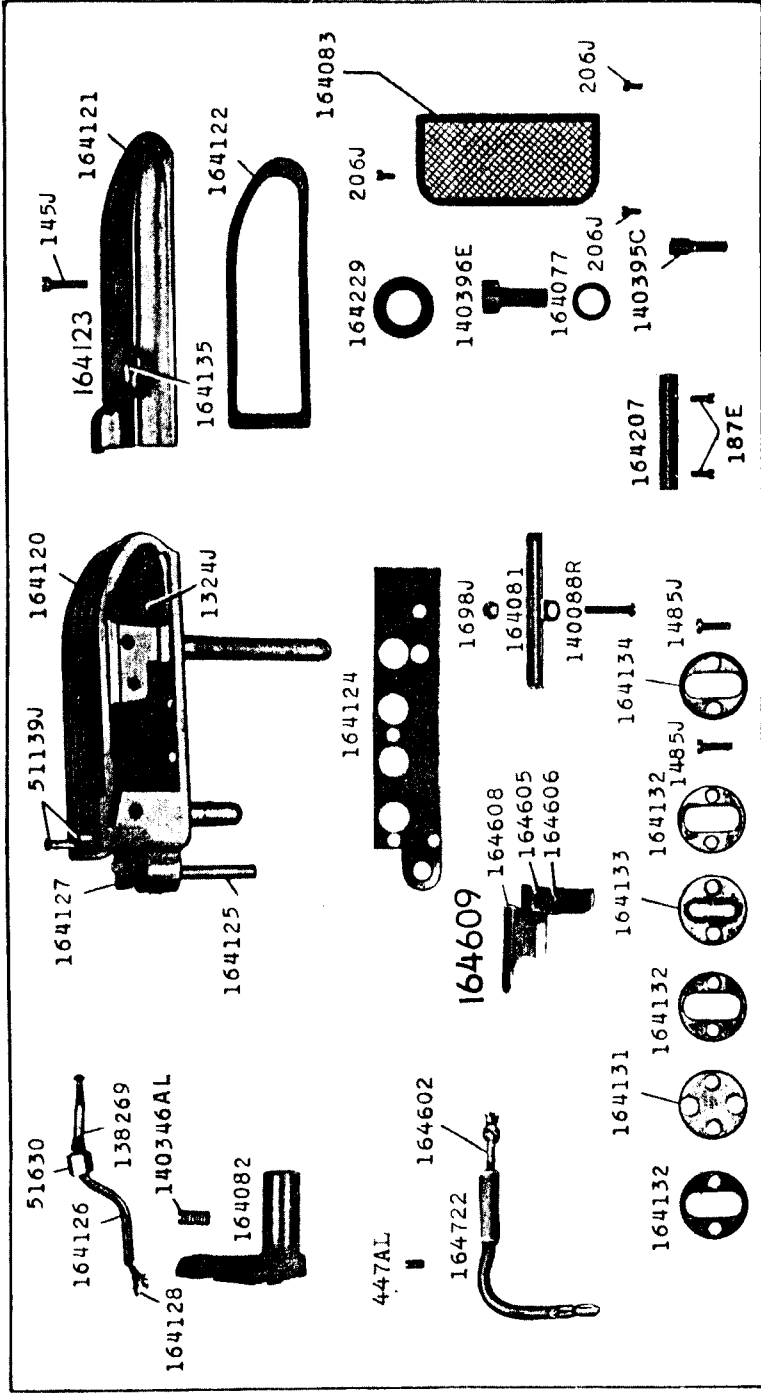

24866 - 1/4

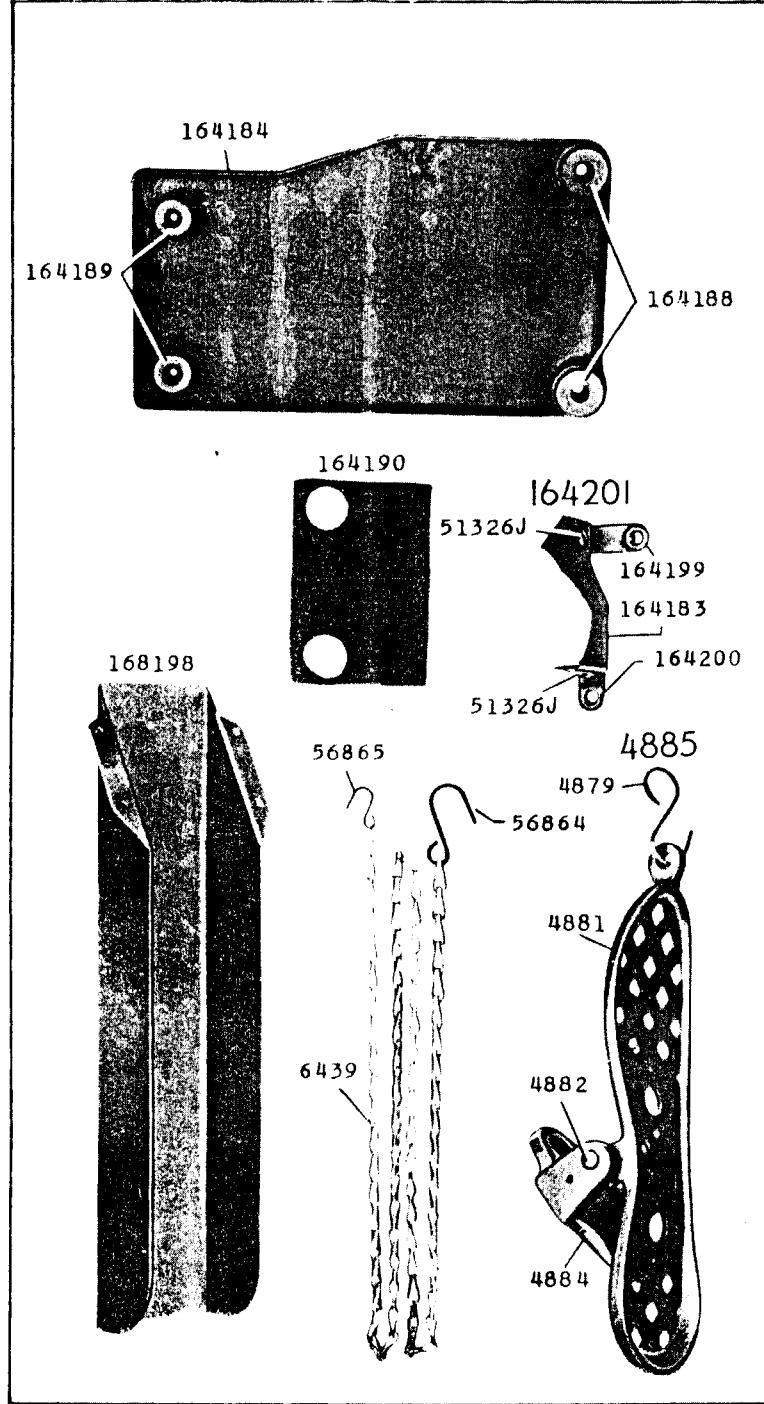

From the library of: Diamond Needle Corp

24867 - 1/6

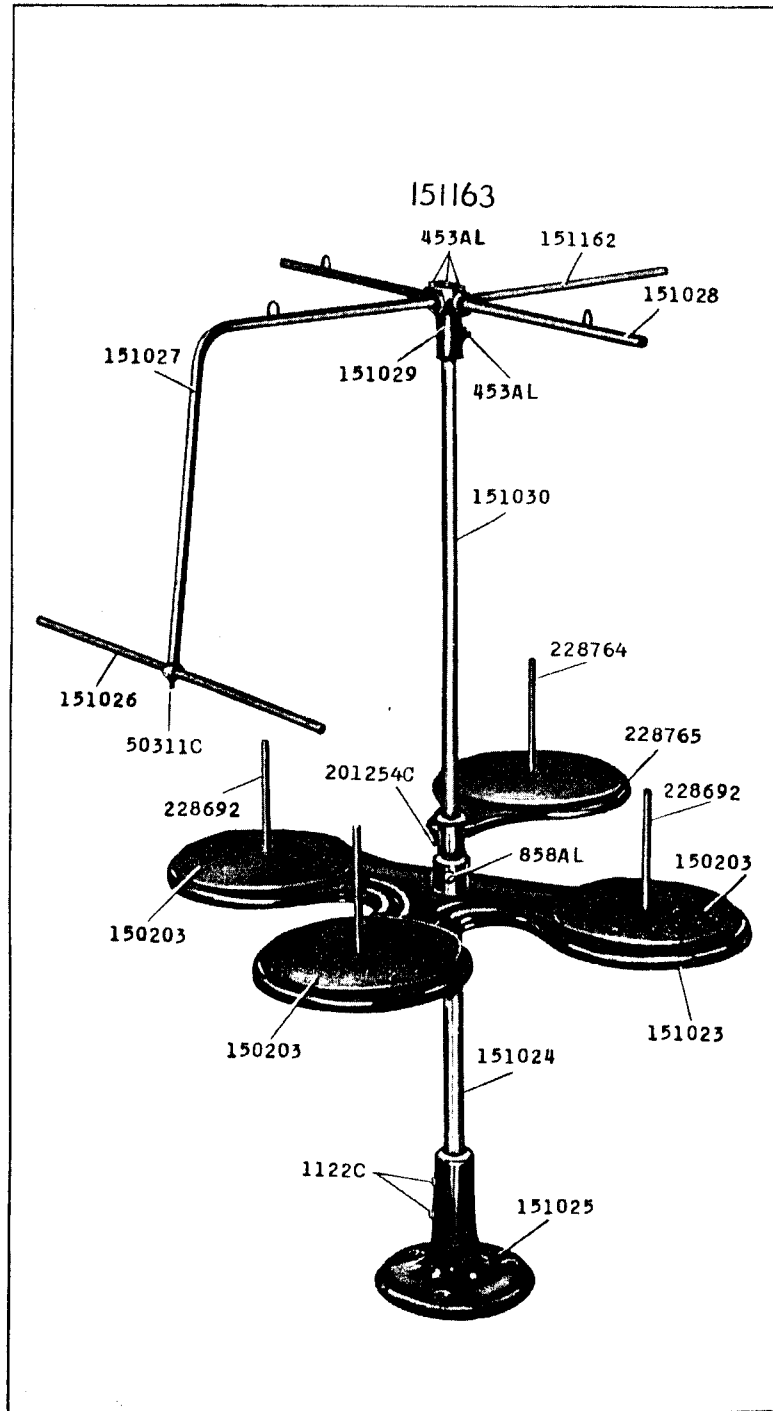

24879 1/2

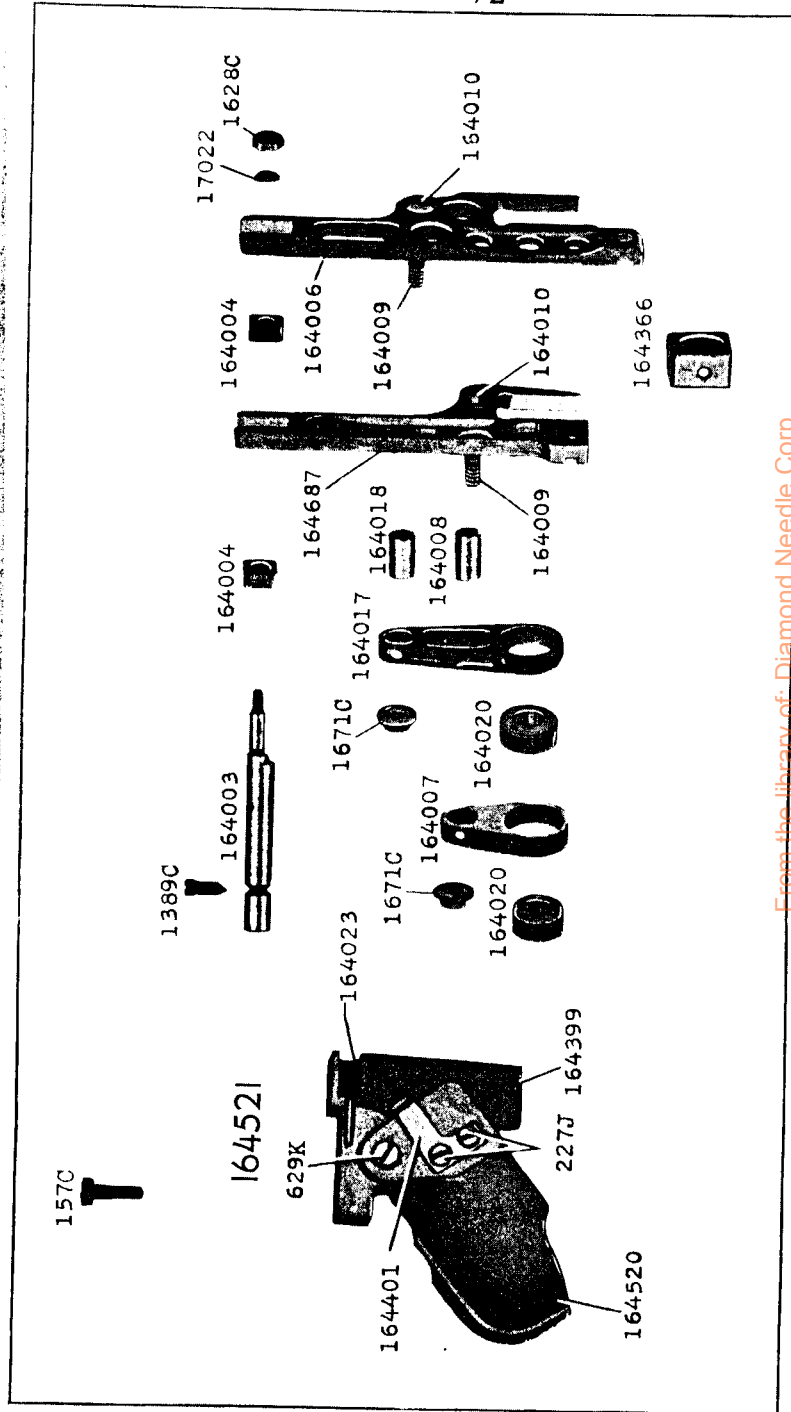

24885 1/3

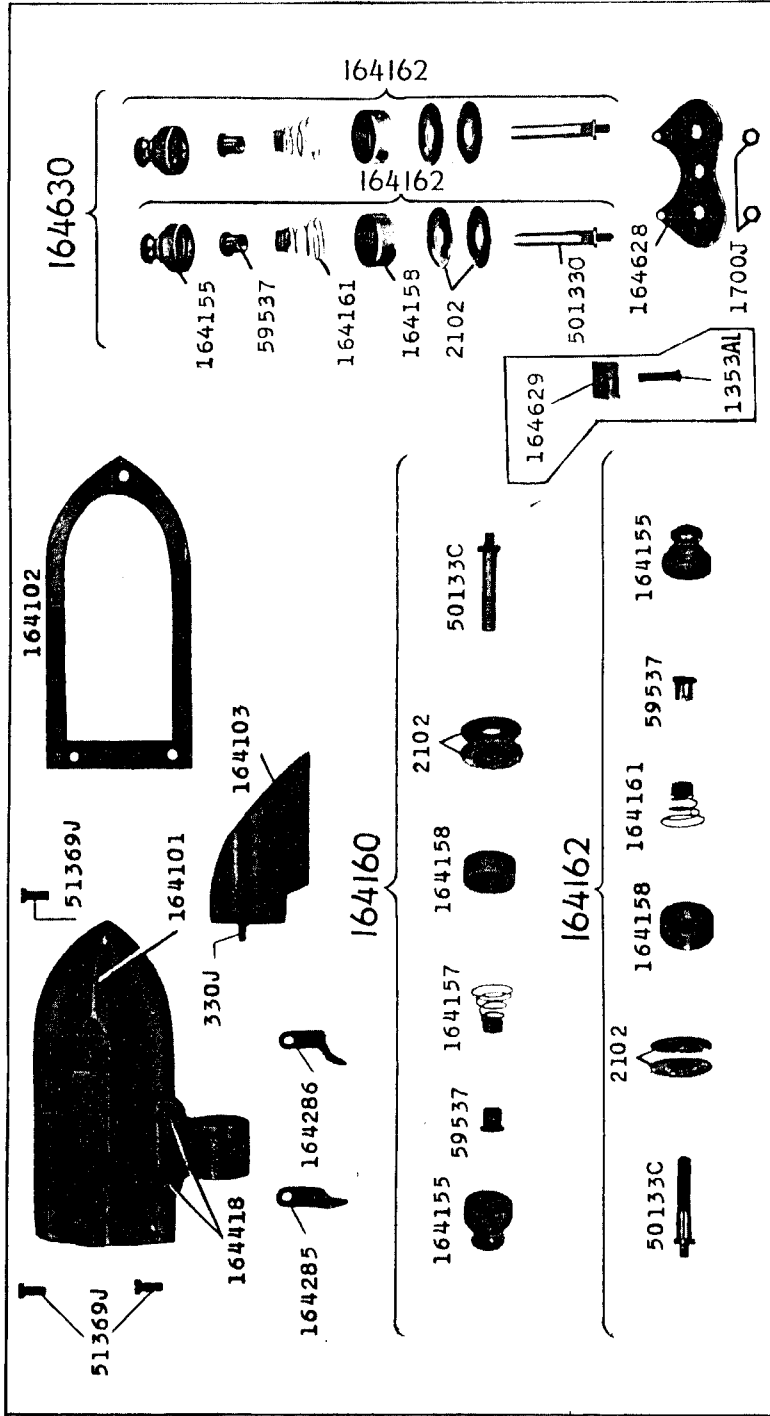

24890 1/2

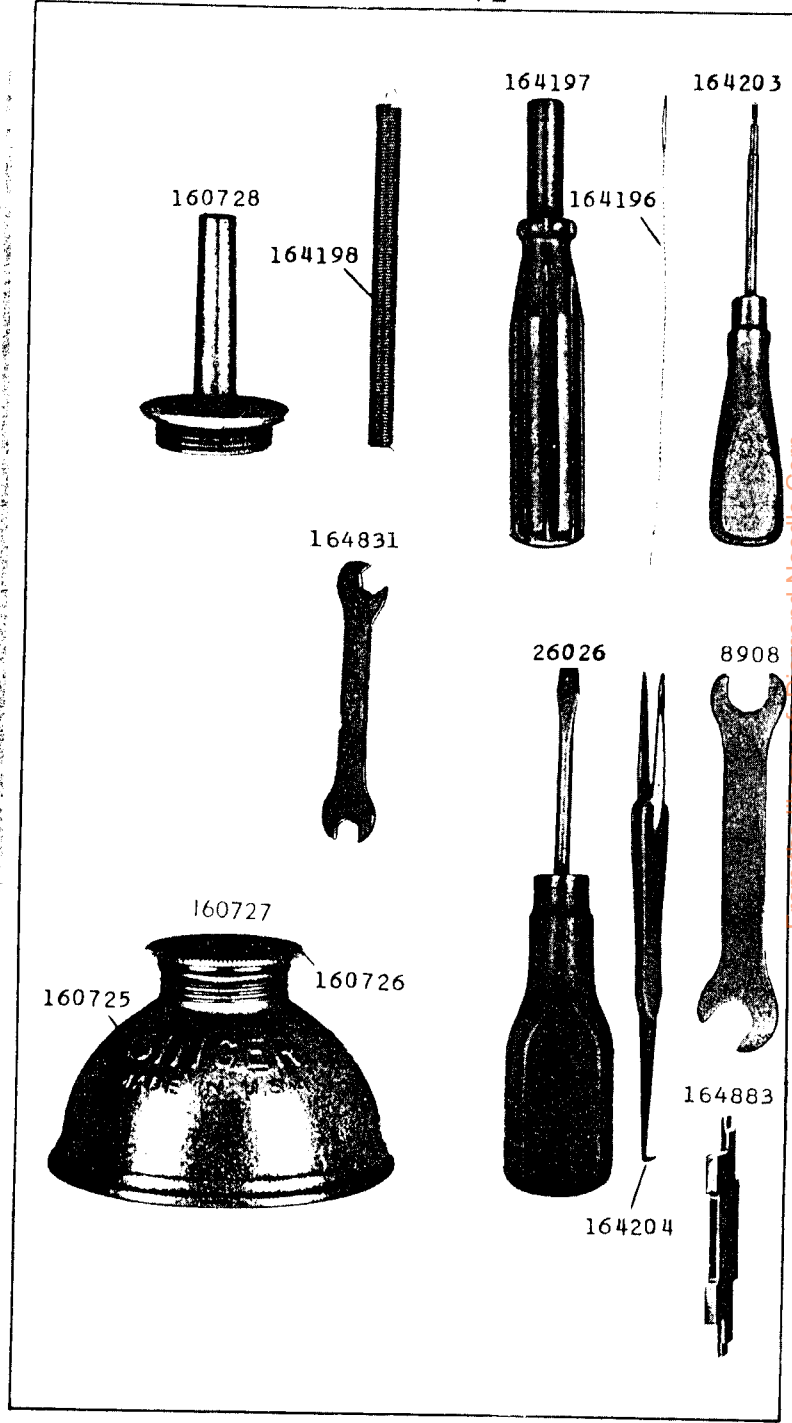

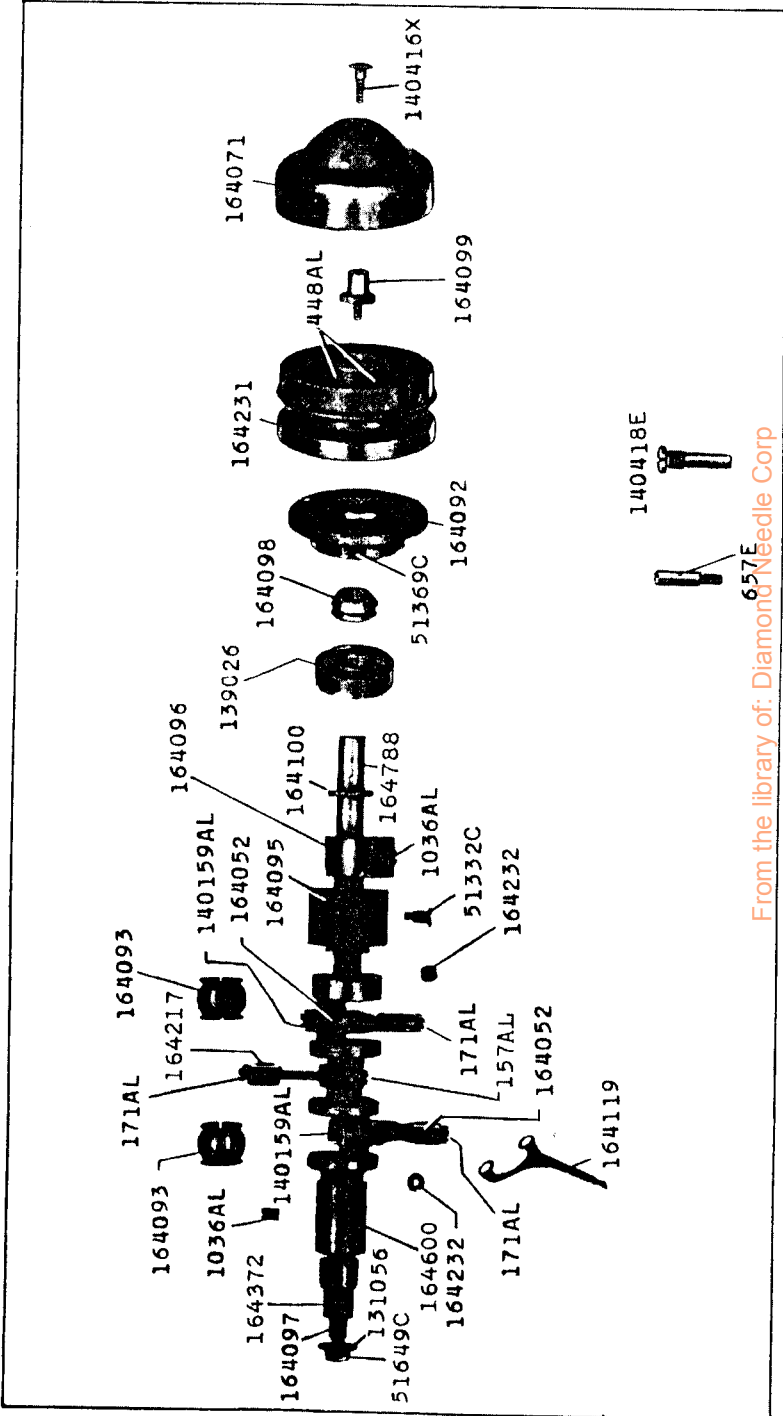
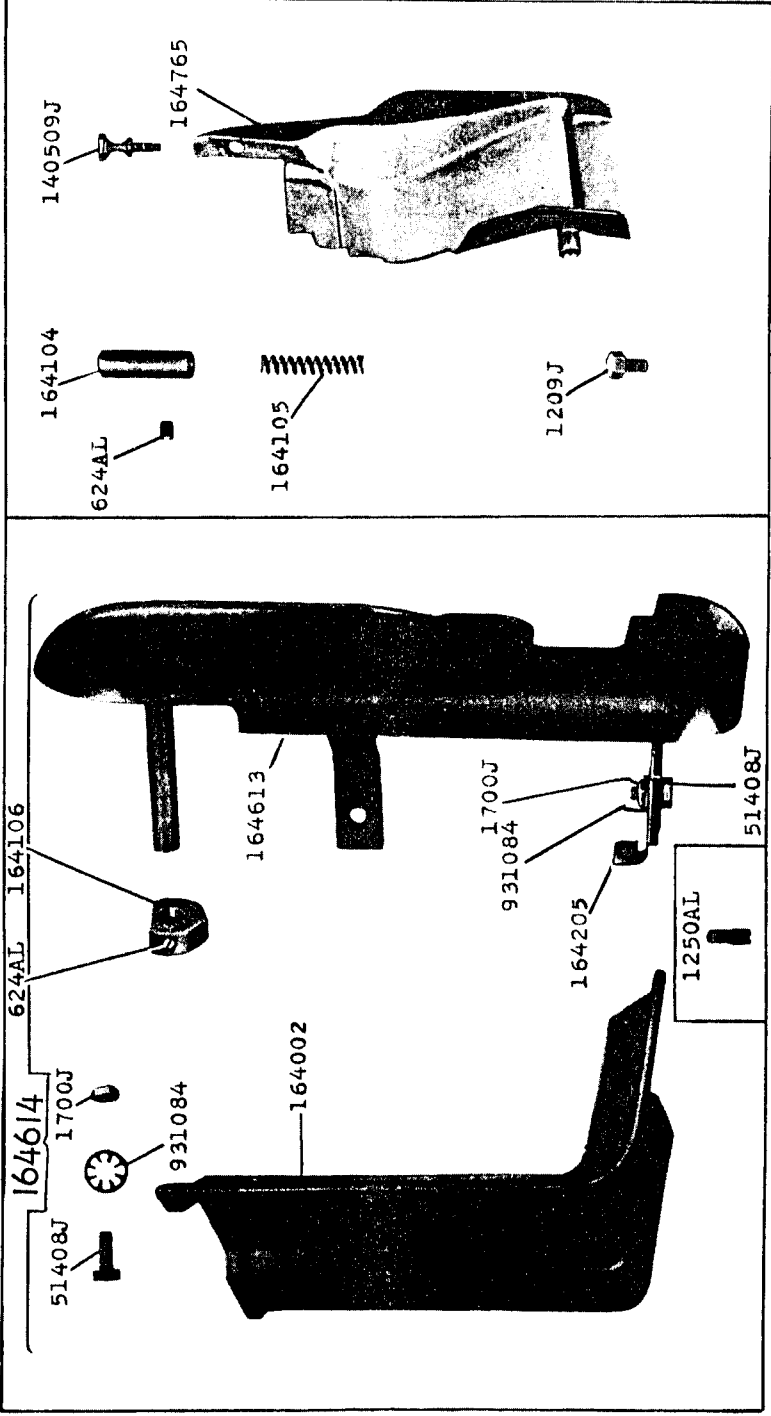

From the library of: Diamond Needle Corp

24893 2/3

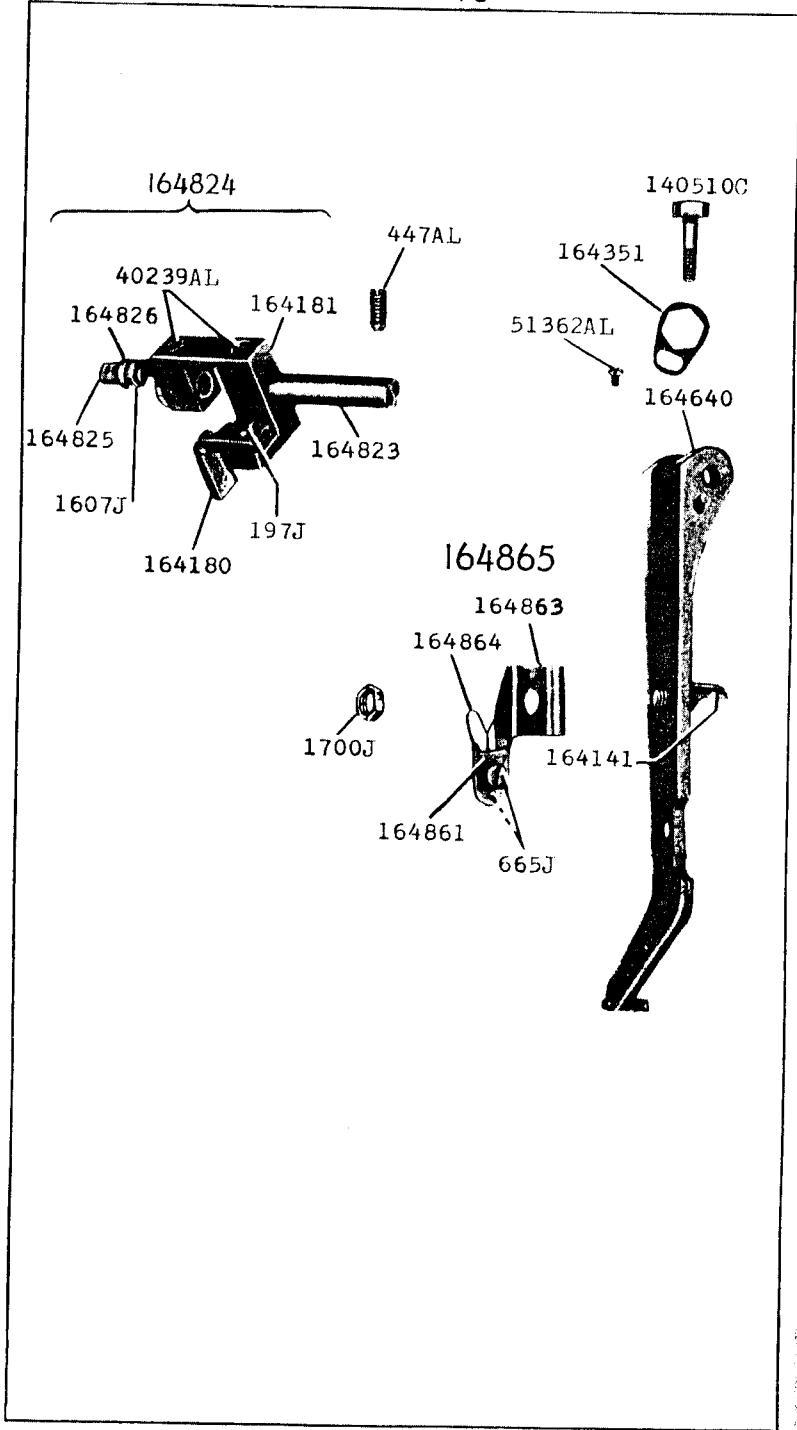

24894 1/2

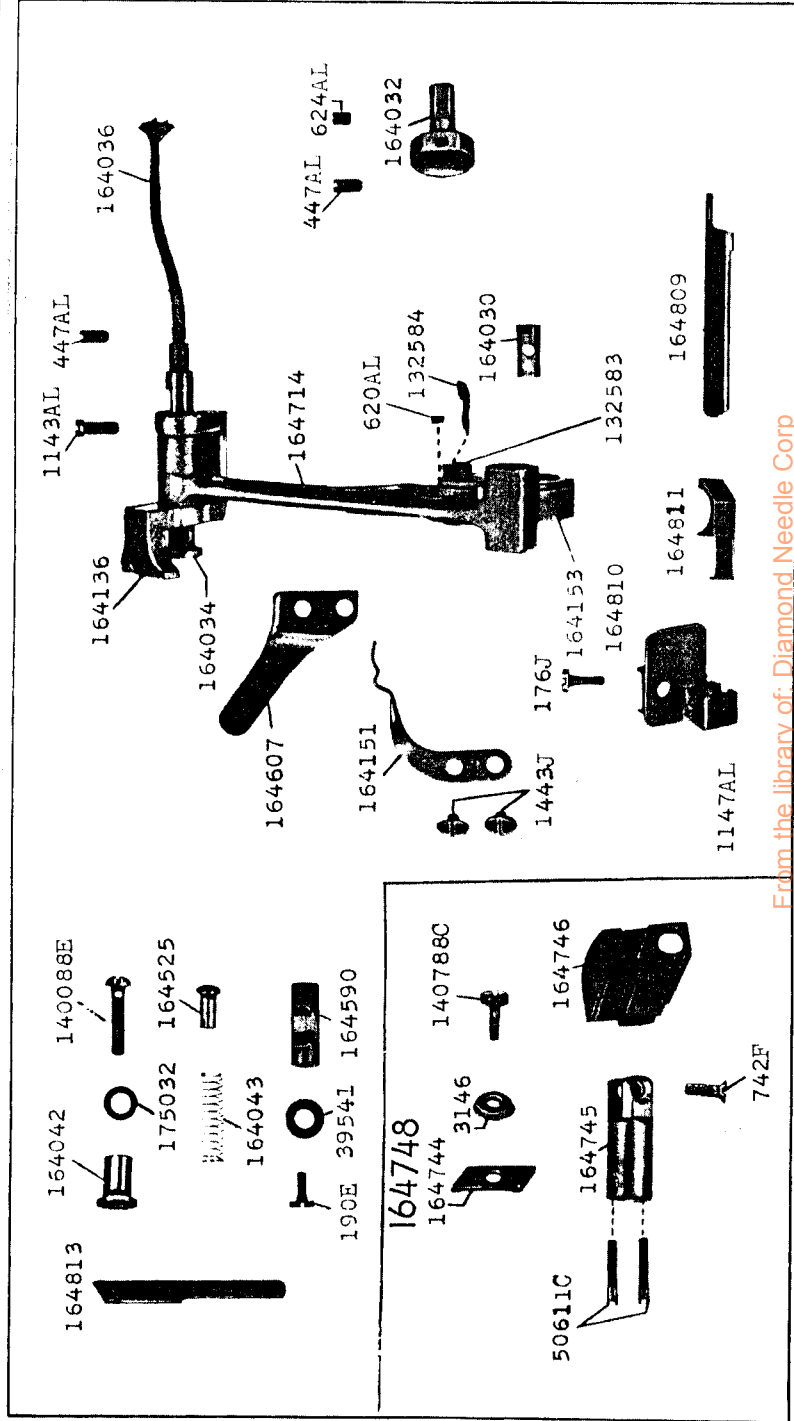

From the library of: Diamond Needle Corp

24895 1/2

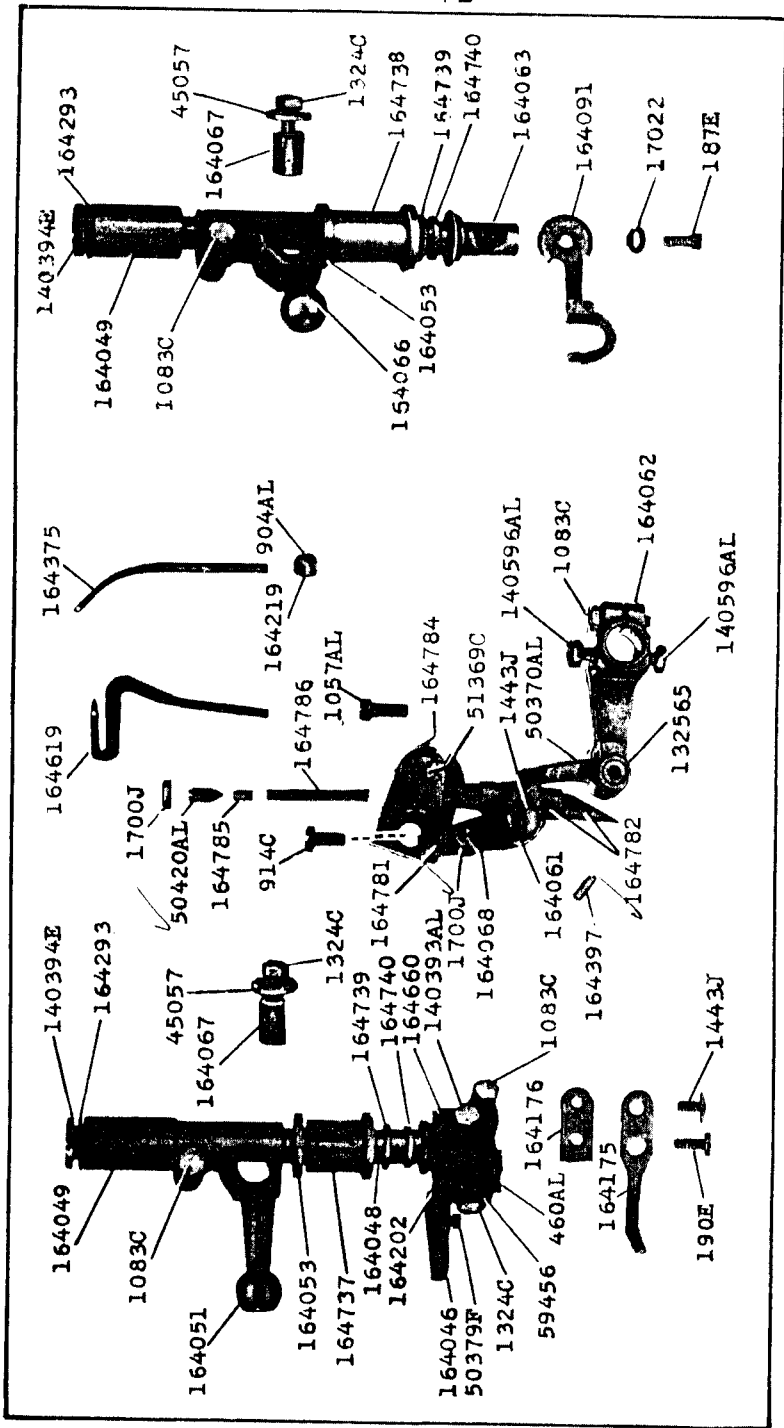

24896 2/3

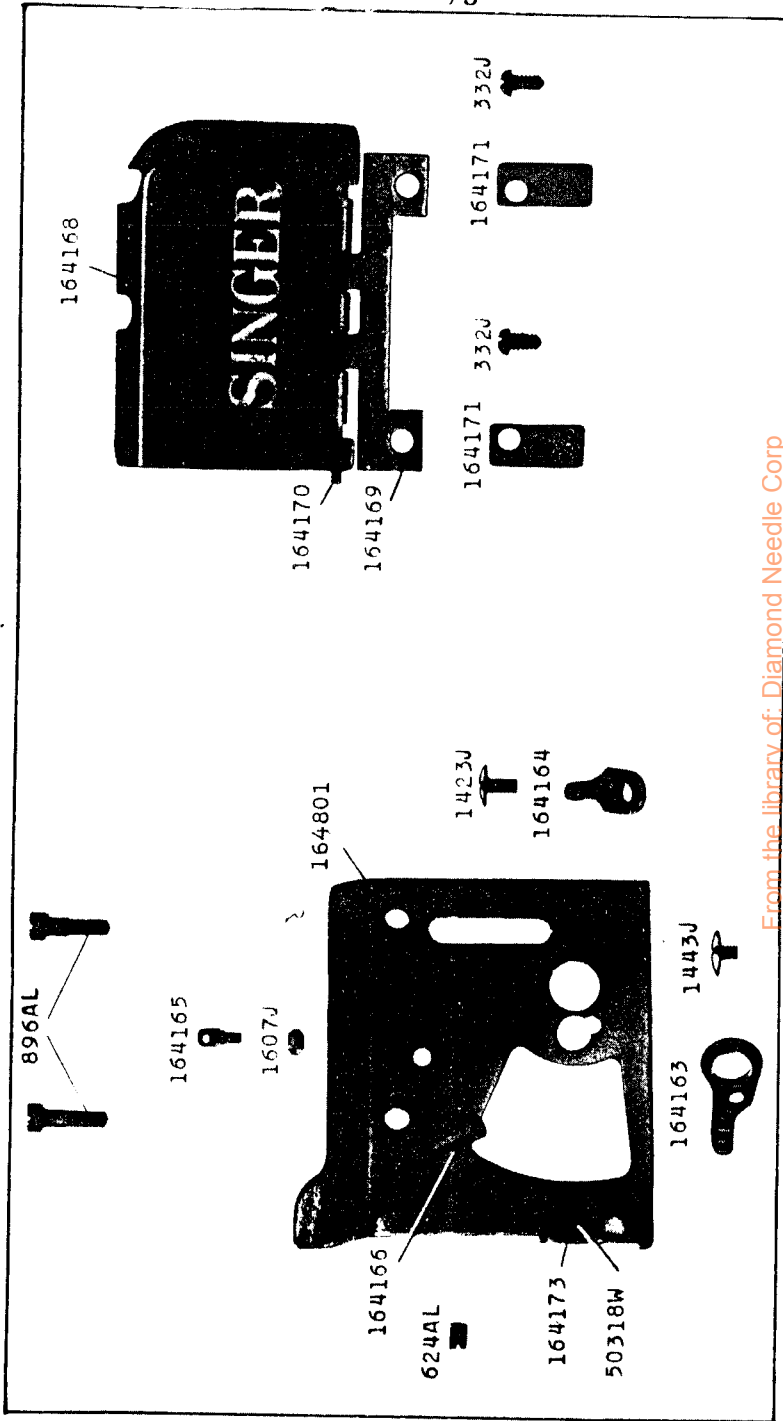

From the library of: Diamond Needle Corp

24897 1/2

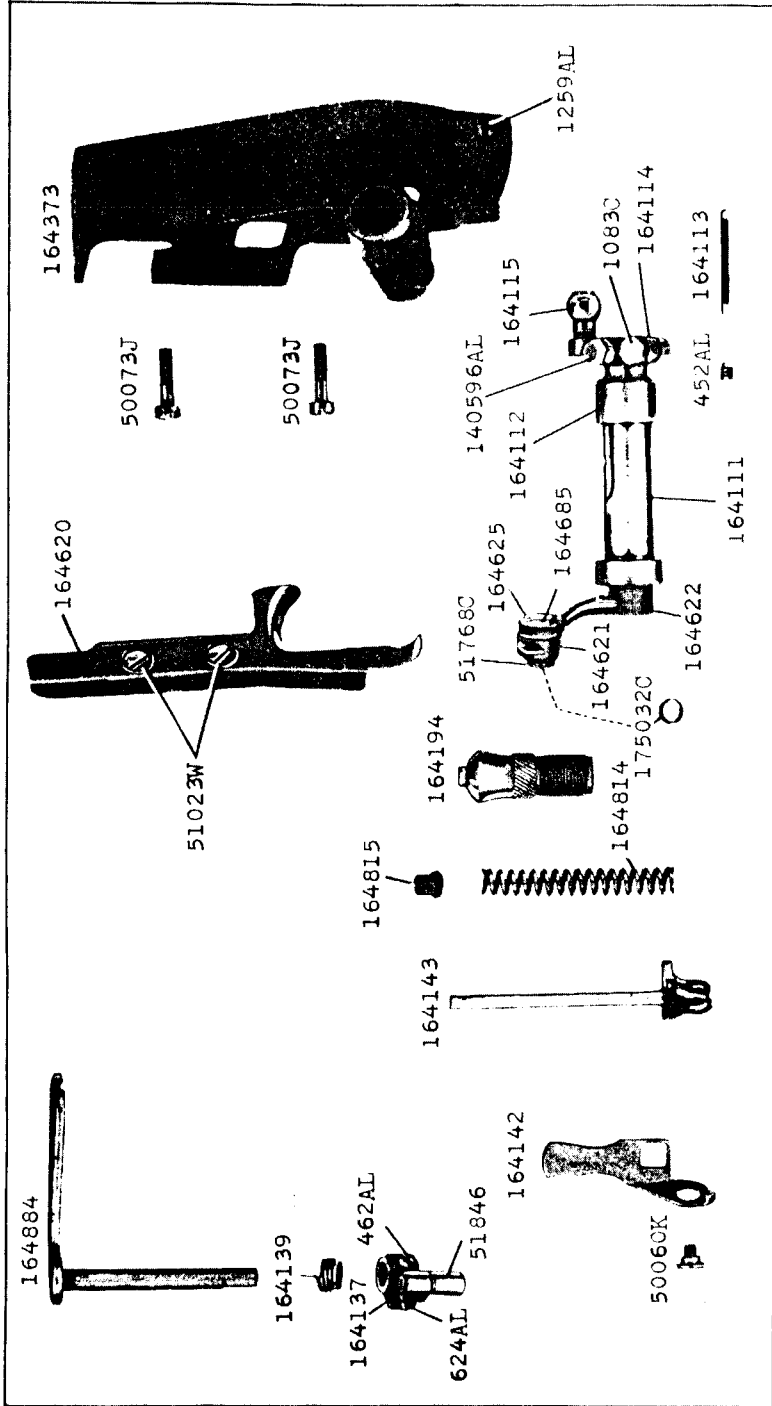

24898 2/3

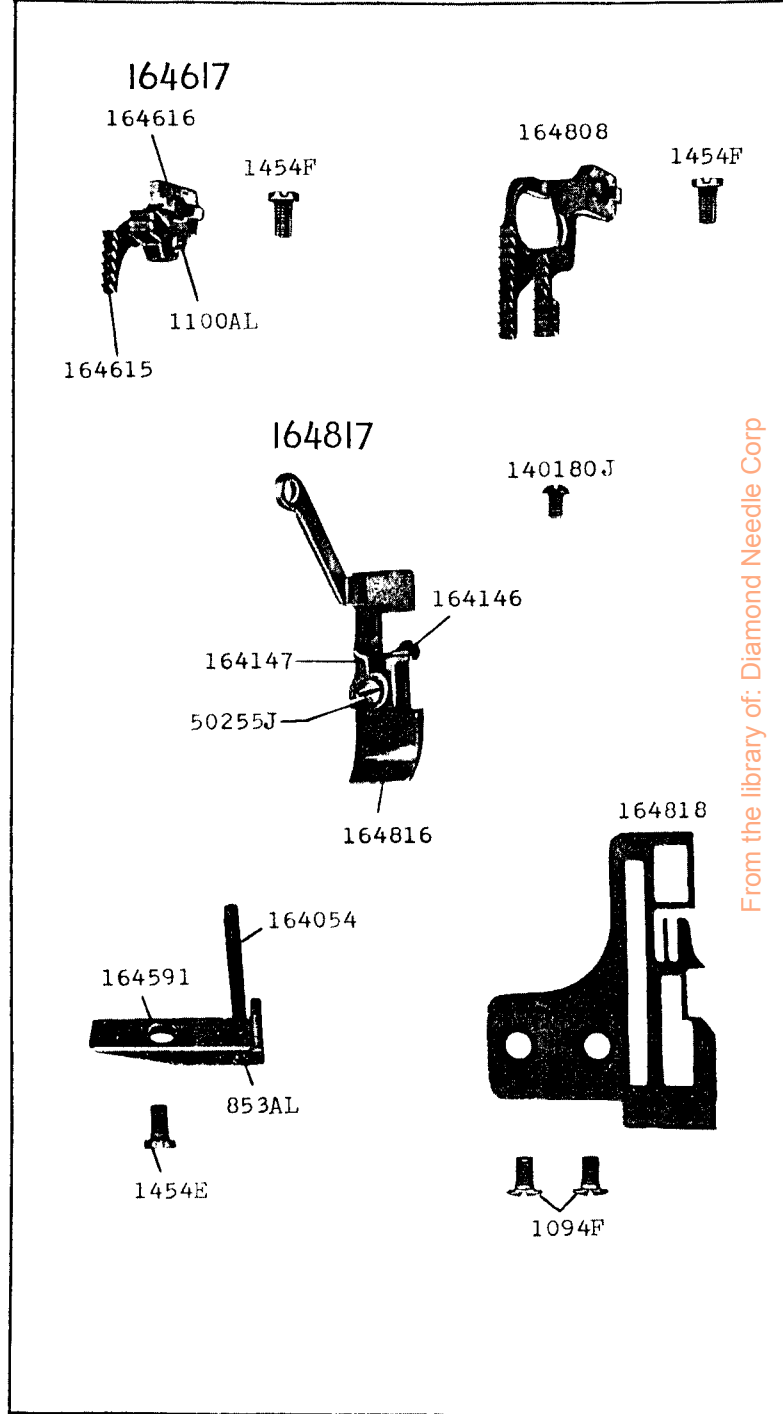

From the library of: Diamond Needle Corp